



ULTIMATE SPEC SUPER CIRCUIT MASTER RACING

IMPREZA STI 05+

TEIN Ride Height and Damping Force Adjustable Shock Absorber Installation Instructions.

Thank you for purchasing a set of TEIN shock absorbers (the "product"). This product complies with JASO automobile standards. This product is designed for **OFF ROAD USE ONLY.**

The product may only be installed in race vehicles, show vehicles and other specially configured vehicles intended for off-road use.

THE PRODUCT MAY NOT BE INSTALLED IN VEHICLES DRIVEN ON PUBLIC ROADS.

The shock absorber's damping force and spring rate (spring hardness) differ from factory standard suspension.

All shock absorbers may be completely disassembled so that changes to damping force and stroke settings (i.e., short stroke suspension) can be made.

Disassembly also provides easy access for overhaul, repair, and maintenance.

However, any disassembly of the shock absorber or any portion of the shock absorber must be performed only by TEIN.

TEIN should be contacted for information as to the scope of disassembly services required, related labor costs, and time necessary to complete any disassembly work. The contact information for TEIN's Downey California office is :

TEIN U. S. A. , INC.

9798 Firestone Blvd. Downey, CA 90241

Phone : (562) 861-9161 / FAX : (562) 861-9171

URL : <http://tein.jp> E-mail : tus_sales@tein.com

TEIN assumes no responsibility for any accident, injuries, death or damage which may be related to disassembly of the product performed by non-TEIN personnel.

Contents

Preface.....	2
Important Product Information.....	3
Before/After Installation.....	4
Shock Absorber Removal, Installation of the Shock Absorber.....	4
Adjustment of Ride Height.....	5 • 6
Damping Force Adjustment After Installation (Applies to Adjustment model only).....	7
Camber / Caster Angle Adjustment (For Applicable models only).....	8 • 9
Important Notice.....	10
Assembly Diagram.....	11 • 12

 **WARNING**

- The removal of brake parts requires specialized skills. Therefore, **INSTALLATION OF THIS PRODUCT SHOULD BE DONE ONLY BY LICENSED MECHANICS.**
- This document is copyrighted and the printing of this document in part or in full, is prohibited by law.

 **CAUTION**

- This product has been developed according to the specifications of Japanese law.
- When using the OEM mounts, use the parts noted with part numbers on these assembly instructions.
- Do not install this product in vehicles other than those specified in this manual. Doing so may result in damage to the vehicle and/or to the product and will void warranty. If you have doubts or questions about fitment of this product on your vehicle, please contact TEIN immediately.
- TEIN assumes no responsibility for damage, accidents, injuries or death resulting from the improper installation, assembly, misuse, and/or modification of the product.

! NOTE

- Please read this Instruction manual before installation.
- Before installing this product, verify that all necessary parts are included.
- Note that product design improvements and changes may be made without notice.

 **CAUTION— READ PRIOR TO INSTALLATION**

Please ensure that all components of the TEIN damper kit are tightened before installation. Items that require tightening are: nut or pillow upper mount nut, seat locks, bracket locks (if applicable), camber plate bolts (if applicable), stabilizer link (if applicable), and/or any other parts. Torque specifications are listed in the installation section of this manual. Please tighten upper mount and lower bracket mounting bolts to OEM specifications, which can be found in the vehicle service manual.

WARNING

- This product contains highly compressed gas. Do not disassemble or expose to flames. Doing so may result in the cracking or explosion of the product. **DO NOT INSTALL THE PRODUCT IF IT HAS BEEN DISASSEMBLED IN ANY WAY.**
- This product has been designed to withstand the stresses of off road driving. Therefore, The product should not be modified in any way.

CAUTION

- If an impact wrench is used in the removal and installation of the upper mount, loads may be placed on the nut inside the shock absorber which may cause loosening or otherwise damage the product.
AN IMPACT WRENCH SHOULD NOT BE USED DURING INSTALLATION unless absolutely necessary. However, if it is imperative that an impact wrench be used, make sure to conduct the operation at **LOW** torque, and **MAKE SURE THAT THE MAIN ROD DOES NOT TURN.**
TEIN assumes no responsibility for loose internal nuts caused by improper impact wrench use.
- When removing or tightening the top nut, **DO NOT CLAMP THE PISTON ROD OR THE THREADED SECTION OF THE PISTON ROD** with any tool which might cause scratching.
- Do not expose this product to shock (for example, physically dropping the product).
- If the rod is damaged or scratched, the oil seal may be damaged which may cause oil leaks.
- To increase the durability and performance of the product, the outer diameter of the product is often much larger than the OEM suspension.
Some vehicle suspensions do not include a dust cover boot due to lack of installation space.
Where no dust cover boot is included, we recommend periodical cleaning of the surface of the rod and inspection of the suspension to help extend the performance.
- Beware that dirt and grit on the damper rod may cause scratches.

Before/After Installation

WARNING

The installer assumes all liability for proper installation of the product. Please read these instructions carefully before beginning installation.

CAUTION

- The upper mount used with this suspension must be a TEIN upper mount or OEM top mount. Upper mounts made by other manufacturers may not properly fit TEIN suspension product.
- **TEIN TAKES NO RESPONSIBILITY FOR ANY DAMAGE TO THE SUSPENSION OR ACCIDENTS RESULTING FROM THE COMBINATION OF THIS PRODUCT WITH PRODUCTS MADE BY OTHER MANUFACTURERS.**
- Installer should wear work gloves when installing the product to avoid injury.
- **PLEASE CHECK YOUR LOCAL MOTOR VEHICLE LAWS AND REGULATIONS REGARDING INSTALLATION OF HEIGHT ADJUSTABLE SUSPENSION SYSTEMS (E. G. MINIMUM RIDE HEIGHT, MINIMUM HEADLIGHT CENTER HEIGHT).**
- TEIN takes no responsibility for any violations of vehicle codes, rules, laws or regulations.
- Upon installation, avoid rough handling and drive slowly.
- Be sure to check product for loosening and oil leaks.
- Periodically re-tighten all parts at the specified torque values.
- After the proper height has been determined, the wheel alignment should be adjusted with an alignment tester.
- The vehicle should be taken to an alignment shop. For reference values, see vehicle manufacture service manual.

Shock Absorber Removal

CAUTION

- Use a spring compressor to compress the spring in order to remove the top lock nut.
- Make sure that the spring is compressed and not in contact with the spring seat and top spring seat before removing the top nut.
- When loosening the spring compressor, loosen the spring evenly and carefully remove the coil from the shock absorber.
- **DO NOT RE-USE THE PISTON ROD TOP LOCK NUT.**

Installation of the Shock Absorber

CAUTION

- (Applies only to adjustable models) The adjustable damper uses a hollow piston rod. To prevent damage to the piston rod, please be **VERY CAREFUL** in the application of torque and usage of impact wrenches.
- (Applies only to adjustable models) Make sure that no tools interfere with the adjustment dial on top of the piston when tightening the nut.
- (Applies only to adjustable models) When the product is manufactured by TEIN, the adjustment dial is automatically set at a full clockwise position. However, after installation is complete, using the hex wrench included with the Product, please confirm that the dial is adjusted to a full clockwise position. From this full clockwise position, use the hex wrench to adjust the dial counter-clockwise for sixteen audible clicks. Avoid further tightening as damage to the damper may result.
- Lowering the vehicle with the lower spring seat at the lowest setting may result in damage to the vehicle.
- Please see the assembly diagram (Page 11 and 12) for the torque values of the piston rod lock nut.

Adjustment of Ride Height

After Installation of the Shock absorber

Front&Rear

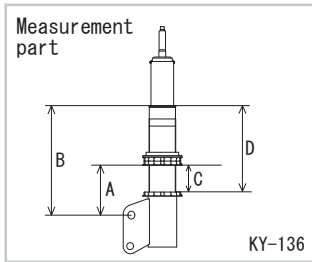

1. After installing the shock absorber on the vehicle, measure the area marked in the Figure, and adjust to match the reference values shown below.

Reference Value (Adjustable range)		
Front	A	93 mm 3.7 inch
	B	205 mm (-15 ~ +20 mm) 8.1 inch (-0.6 ~ +0.8 inch)
	C	37 mm (1.5 inch)
	D	149 mm (5.9 inch)
Rear	A	197 mm 7.8 inch
	B	305 mm (± 20 mm) 12.0 inch (± 0.8 inch)
	C	141 mm (5.6 inch)
	D	251 mm (9.9 inch)

! CAUTION

※1inch=25.4mm

- ABOVE IS THE REFERENCE VALUE TO BE USED WITH THE STANDARD RATE SPRINGS.
(Supplied with this product).

! NOTE

- Lubricant is used on the product body threads to prevent rust after being manufactured. This lubricant is not oil leaking from the product.

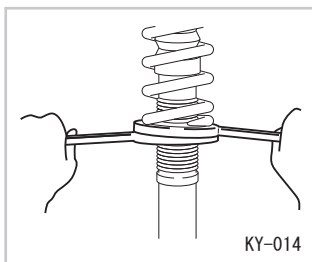

2. After adjusting to the appropriate height, use the adjustment wrench included with the Product to lock the lower spring seat.

When servicing, hold the lower spring seat with the wrench, and turn/screw the seat lock upwards, tightening about 1/8(45°)turns from where the lower spring seat and seat lock meet.

Before driving, you must lock the lower bracket.

Screw the lower bracket with following torque.

Strut type 137.3±4.9 N.m (101.2±3.6 ft·lbf) (14.0±0.5kgf·m)

Wishbone/Multi-link type 68.6±2.45 N.m (50.6±1.8 ft·lbf) (7.0±0.25kgf·m)

Adjustment of Ride Height

⚠ CAUTION

- Please make sure that the spring seat lock is locked after the ride height is adjusted.
- Gravel or dirt may have adhered to the adjustment tube.
- The threads of the seat lock and lower spring seat may become damaged, and causing the seat lock to stick, if gravel and dirt are not cleaned/removed before adjustment.

! NOTE

- If the parts do not screw smoothly, use a lubricant. To prevent the sticking of the seat lock and spring seat, it is recommended that the pieces be periodically maintained. (inspected, cleaned, oiled)

⚠ CAUTION

- **AFTER RIDE HEIGHT ADJUSTMENT, CONFIRM THAT SPRING SEAT IS LOCKED. FAILURE TO LOCK SPRING SEAT MAY RESULT IN DAMAGE TO THE VEHICLE.**

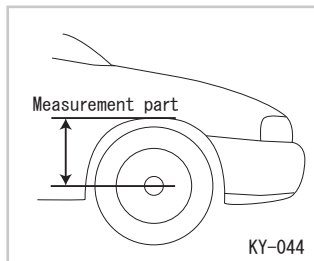

3. After installing the tires, measure the distance from the wheel center and the fender edge as shown in the Figure, and confirm that it corresponds to the reference value shown below.

Reference Value	
Front	13.4 inch (340 mm)
Rear	13.0 inch (330 mm)

⚠ CAUTION

- **ABOVE IS THE REFERENCE VALUE TO BE USED WITH THE STANDARD RATE SPRINGS.** (Supplied with this product).

⚠ CAUTION

- **THE FIGURE ABOVE MAY VARY DEPENDING UPON VEHICLE WEIGHT, MODEL, AND OPTIONS.**

⚠ CAUTION

- The lowering of the ride height correlates to the spring rate.
- Depending on the spring rate, the ride height may not drop as easily.
- If the spring rate is changed, readjust the ride height.
- When using a spring rate lower than the standard spring rate, the spring seat may require adjustment.

When shipped from the manufacturer, the adjustment knob is set at the stiffest setting (full clockwise). Confirm that the adjustment knob (located at the top of the piston rod) has not been moved from this position.

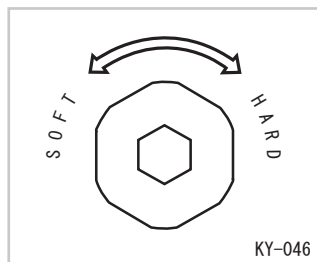

1. Use the included wrench (HEX wrench) to turn the adjustment knob on top of the piston rod to the hardest setting (full clockwise). (This is the initial damping setting.)
2. From the full clockwise position, turn the adjustment knob counterclockwise until the "Recommended Values" listed below are reached.

! CAUTION

- DO NOT turn knob past the last position(16).
- Turning the knob past its limit will result in damage to the damper.

If the knob comes to a stop at a half way point, turn back slightly until it clicks into place.

! NOTE

- The adjustment knob can turn past the 16 click limit. But doing so has no effect on the damping force and continually doing so may result in damage of the shock.
- Every time the damper is adjusted, it must first be set to the stiffest setting and then adjusted to desired setting.

Standard Value (from hardest setting)		Rebound		Compression	
		Front	Turn back 8 clicks	Turn back 8 clicks	Turn back 8 clicks
	Rear	Turn back 8 clicks	Turn back 8 clicks	Turn back 8 clicks	Turn back 8 clicks

* Click Knob Location Strut Type(Inverted Type) :Top=For Compression / Bottom=For Rebound
 * Click Knob Location S/A Type(EX Tank) :Top=For Rebound / EX Tank=For Compression

! CAUTION

- If the springs used are harder than the standard set, adjust damping to a harder setting.
- Drive at the recommended settings, and adjust as necessary to the preferred settings.

! NOTE

- According to the driving setting (i.e. race track) certain vehicles may require uneven damping force on the left and right sides of the vehicle.
- If the front and rear balance is not proper, adjust either the rear or the front pair of damping only.

! CAUTION

- Some vehicle models require the removal of interior parts for adjustment.

! NOTE

- You may wish to remove interior parts while setting the damping force.
- A hole may be made in the interior for the adjustment knob.
- For the protection of the adjustment knob, the add cap (rubber cap) should be used to cover the knob.

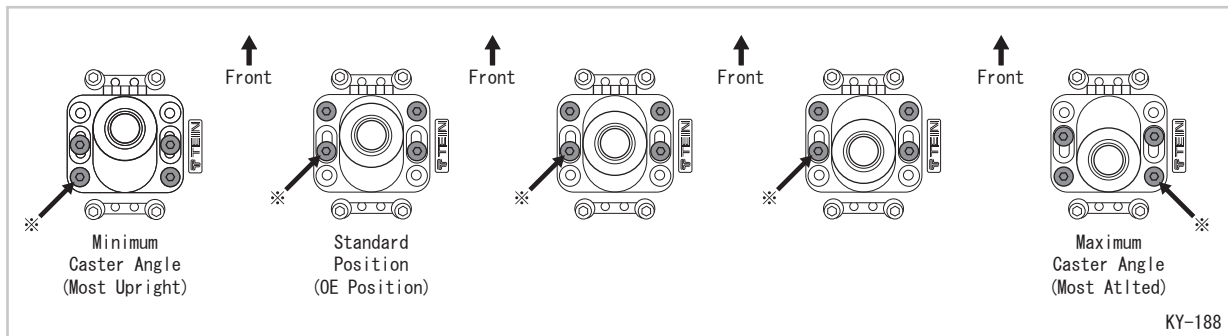

Camber Adjustment

The zero "0" on the scale indicates the OE center-hole position. To adjust the camber angle, jack-up and secure the vehicle (make sure the tires are not touching the ground), and then loosen the adjusting bolts.

! NOTE

- Loosen the bolts and/or remove as necessary but DO NOT remove all bolts at once. Adjust [slide] the camber position in small increments to find the best possible setting. Both driver and passenger side should be adjusted equally.

Caster Adjustment

The caster angle can be adjusted to five (5) different settings by changing the position of bolt(s) marked with "※". To adjust the caster angle, jack-up and secure the vehicle (make sure the tires are not touching the ground), and then loosen or remove the adjusting bolts.

*Standard position is 2 steps from the front side.

! CAUTION

- Tighten adjusting bolts (4 ea.) at the specified torque after camber and/or caster angle adjustments are made.
 - ☑ camber : 16.7 ~ 18.6 N·m (12.3 ~ 13.7 ft·lbf) (1.7 ~ 1.9 kgf·m)
 - ☑ caster : 8.0 N·m (5.9 ft·lbf) (0.8 kgf·m)
- Pay attention when adjusting the camber angle in the negative direction. OE brake hose bracket and the vehicle body may interfere when the camber angle is adjusted in the negative direction by 3 or more increments (tick marks). (May vary depending on vehicle) Doing so requires extra precaution to ensure no parts are binding or hitting.
- Loosen camber bolt(s) prior to caster angle adjustment. Special precaution should be taken when adjusting the caster angle, as all fastening bolts on the caster side may need to be loosened/ removed depending on the adjustment position.

Camber Angle Adjustable Lower Bracket

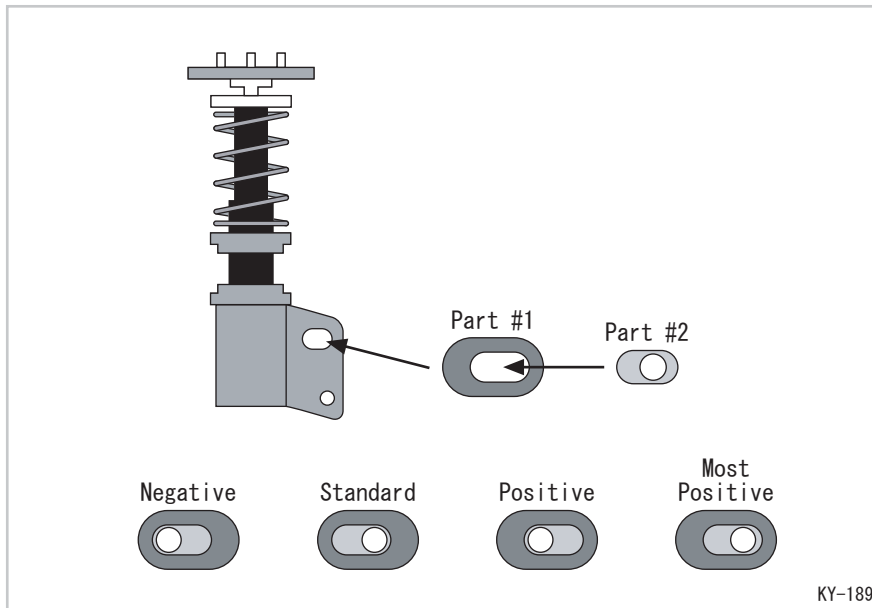

- Eccentric collars #1 & #2 enable camber adjustment in 4 different settings on the upper bolt of the lower mounting bracket. Adjustments can easily be made by loosening those bolts and rotating (180 degrees) both #1 and #2 collars horizontally.
- This lower bracket camber adjustment is especially useful in fitting wider tires/ rims as the clearance between shock and tire /rim can be adjusted.
- Camber angle adjustment at upper mount also affects kingpin angle and scrub radius as a result, it also is effective in the adjustment of overall geometry.

Important Notice

1. ALL TEIN PRODUCTS ARE FOR OFF-ROAD USE ONLY. All TEIN lowering springs, coilovers, and various other products may be deemed illegal for street use. Based upon ride height regulations, and suspension restrictions for each city, county, state, and/or country.
2. TEIN takes no responsibility for parts which are prohibited by local, county, state, and federal laws. It is the consumer/purchasers sole responsibility to ensure that these products are deemed legal for street use.
3. Purchaser takes full responsibility for proper installation, setting adjustment, and any alignment related issues.
4. All parts should be properly installed by a licensed and/or certified mechanic.
5. TEIN will not take any responsibility for errors and/or omission in these installation instructions.
6. Noise from suspension is normal, and does not affect the performance or safety. Therefore noise issues are not covered under product warranty.
7. TEIN highly recommends that the suspension is installed at the TEIN recommended ride height and settings upon first use.
8. TEIN takes no responsibility for damage, injuries, or death caused directly or indirectly by this product.
9. By installation and/or use consumer agrees to the above stated notices.

MEMO

Assembly Diagram (Front)

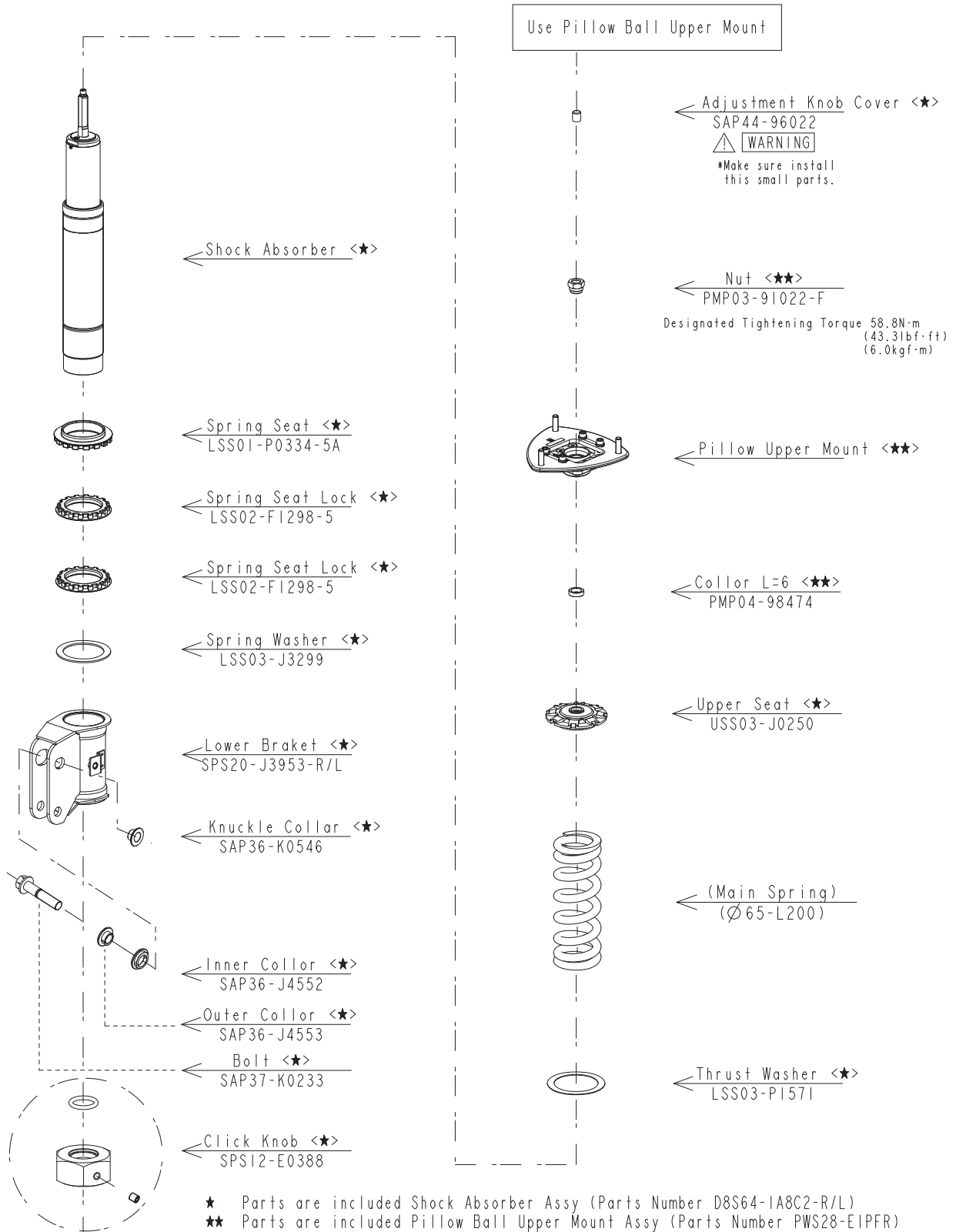

Assembly Diagram (Rear)

